

SN70093 - CONTACT WASHER

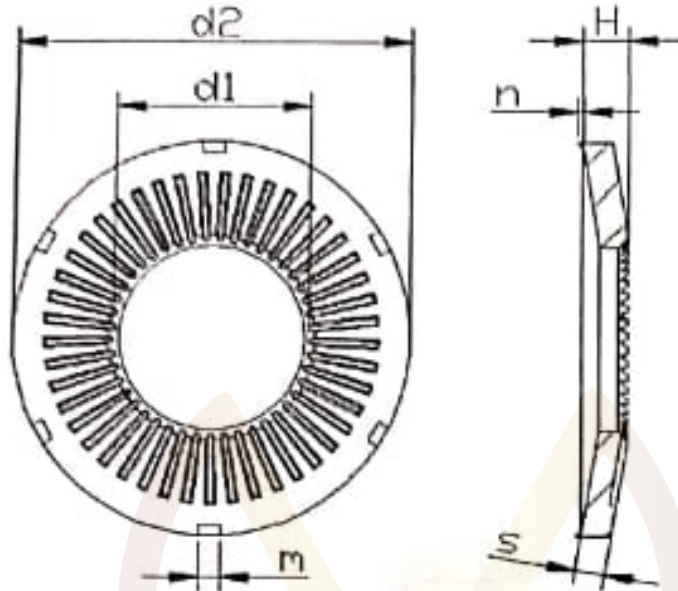

SPECIFICATIONS

Specs	d1		d2		h		m		n		s	
	Size	Tolerance	Size	Tolerance	Size	Tolerance	Size	Tolerance	Size	Tolerance	Size	Tolerance
3	3.1	+ 0.3	6.2	- 0.4	0.95	- 0.15	0.8	± 0.1	0.2	+ 0.2	0.6	± 0.05
3.5	3.6		7.2		1.1		1		0.2		0.7	
4	4.1		8.2		1.15		1.2		0.2		0.8	
5	5.4	+ 0.3	10.2	- 0.4	1.5	- 0.25	2	± 0.2	0.4	- 0.3	1	± 0.1
6	6.1		12.2		1.8		2		0.4		1.2	
8	8.2		16.2		2.4		2		0.4		1.4	
10	10.2	+ 0.4	20.25	- 0.5	2.6	- 0.45	2	± 0.2	0.4	- 0.1	1.6	± 0.1
12	12.4		24.25		2.6		2		0.4		1.6	
16	16.4		32.3		3.96		4.5		0.4		2.5	
20	20.5	+ 0.5	40.3	- 0.6	4.65		4.5		0.4	+ 0.4	3	

SPECIFICATIONS & DETAILS

MVD PART CODE	MVSN70093MXX	MVD DESCRIPTION	CONTACT WASHER TOOTHED SS316 MXXX
DRAWN BY	ABHISHEK	APPROVED BY	MAGESH
DRAWING REV. NO	00	MATERIAL	SS316
DATE		FINISH	NATURAL

ALL DIMENSIONS ARE IN MM, UNLESS SPECIFIED

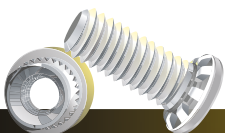

#308, Jigani-Bommasandra Link Road, Jigani, Anekal Taluk, Bengaluru - 560 105, INDIA.